

Technical data sheet

Locknut, metric thread

Item number: 2049503



Locknut to DIN 46319, with metric thread IEC 423.

Note: Only tighten polystyrene cable glands lightly due to the risk of stress crack formation.



PS Polystyrene

Master data

Item number	2049503
Type	116 M12 LGR PS
Description 1	Locknut
Manufacturer	OBO
Dimension	M12
Colour	Light grey; RAL 7035
Material	Polystyrene
Smallest sales unit	100
Unit of quantity	Piece
Weight	0.075 kg
Weight unit	kg/100 pc.

Technical data sheet

Locknut, metric thread

Item number: 2049503



Dimensions



Dimension E	19 mm
Dimension L	5 mm

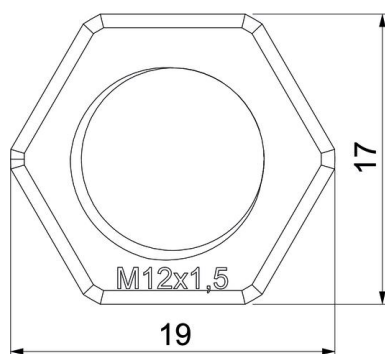

Technical data

Thread	M12_x_1,5
Thread type	Metric
Nominal thread size metric/PG	12
Fibre-glass reinforced	no
Halogen-free	yes
Impact-resistant	yes
WAF	17