

# Technical data sheet

## Locknut, PG thread

Item number: 2043297



Locknut DIN 46320, with PG thread DIN 40430.

Note: Only tighten polystyrene cable glands lightly due to the risk of stress crack formation.



**PS** Polystyrene

### Master data

Item number	2043297
Type	116 PG29
Description 1	Locknut
Manufacturer	OBO
Dimension	PG29
Colour	Light grey; RAL 7035
Material	Polystyrene
Smallest sales unit	50
Unit of quantity	Piece
Weight	0.573 kg
Weight unit	kg/100 pc.

# Technical data sheet

Locknut, PG thread

Item number: 2043297



## Dimensions



Dimension E	50 mm
Dimension L	7 mm

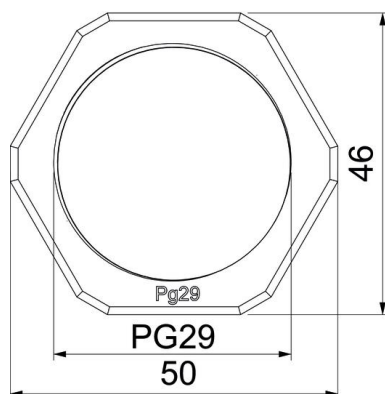

## Technical data

Thread	Pg_29
Thread type	PG
Nominal thread size metric/PG	29
Fibre-glass reinforced	no
Halogen-free	yes
Impact-resistant	yes
WAF	46