

Technical data sheet

Locknut, PG thread

Item number: 2043424



Locknut DIN 46320, with PG thread DIN 40430.

Note: Only tighten polystyrene cable glands lightly due to the risk of stress crack formation.



PS Polystyrene

Master data

Item number	2043424
Type	116 PG42
Description 1	Locknut
Manufacturer	OBO
Dimension	PG42
Colour	Light grey; RAL 7035
Material	Polystyrene
Smallest sales unit	25
Unit of quantity	Piece
Weight	1.089 kg
Weight unit	kg/100 pc.

Technical data sheet

Locknut, PG thread

Item number: 2043424



Dimensions



Dimension E	73 mm
Dimension L	8 mm

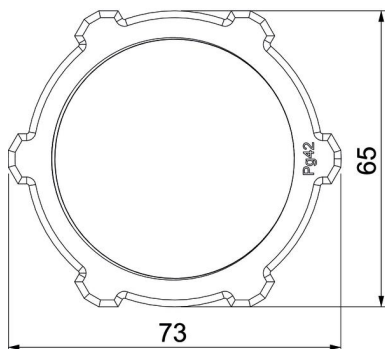

Technical data

Thread	Pg_42
Thread type	PG
Nominal thread size metric/PG	42
Fibre-glass reinforced	no
Halogen-free	yes
Impact-resistant	yes
WAF	65