

Technical data sheet

Locknut, PG thread, light grey

Item number: 2048426



Locknut DIN 46320, with PG thread DIN 40430.



PA Polyamide

Master data

Item number	2048426
Type	116 VDE PG42 PA
Description 1	Locknut
Manufacturer	OBO
Dimension	PG42
Colour	Light grey; RAL 7035
Material	Polyamide
Smallest sales unit	25
Unit of quantity	Piece
Weight	1.756 kg
Weight unit	kg/100 pc.

Technical data sheet

Locknut, PG thread, light grey

Item number: 2048426



Dimensions



Dimension E	73 mm
Dimension L	8 mm

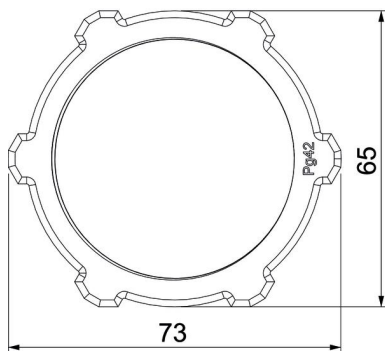

Technical data

Thread	Pg_42
Thread type	PG
Nominal thread size metric/PG	42
Fibre-glass reinforced	no
Halogen-free	yes
Impact-resistant	no
WAF	65