

Technical data sheet

Counter-trough, metal universal, DD

Item number: 1199862



Metal counter-trough, for mounting on clamp clip. Can be used universally, irrespective of the rail.



St Steel

DD Strip galvanised zinc/aluminium, Double Dip

Master data

Item number	1199862
Type	2058FW M 22 DD
Description 1	Counter-trough
Manufacturer	OBO
Dimension	16-22mm
Material	Steel
Surface	Strip galvanised zinc/aluminium, Double Dip
Surface standard	DIN EN 10346
Smallest sales unit	100
Unit of quantity	Piece
Weight	1.2 kg
Weight unit	kg/100 pc.

Technical data sheet

Counter-trough, metal universal, DD

Item number: 1199862



Dimensions



Dimension B	28 mm
Dimension H	8.8 mm
Dimension L	35 mm

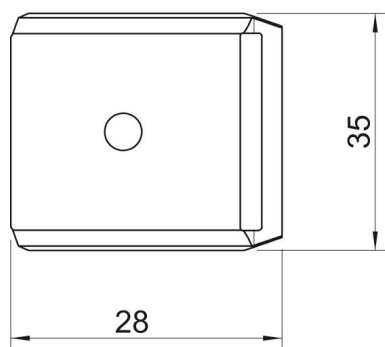

Technical data

Counter-trough/clip version	Counter sleeve
Suitable for max. cable diameter	22 mm
Halogen-free	yes
Clamping range D, max.	22 mm
Clamping range D, min.	16 mm