

# Technical data sheet

## Cover for 45° Magic bend FS



Item number: 7138372

Cover for 45° bend with pre-mounted turn buckles.  
The cover can be used with fittings of all side heights.



**St** Steel

**FS** Strip galvanized

### Master data

Item number	7138372
Description 1	45° bend cover
Description 2	for bend RBM 45 600
Manufacturer	OBO
Dimension	B=600mm
Material	Steel
Surface	Strip galvanized
Surface standard	DIN EN 10346
Smallest sales unit	1
Unit of quantity	Piece
Weight	191.5 kg
Weight unit	kg/100 pc.

# Technical data sheet

## Cover for 45° Magic bend FS

Item number: 7138372



### Dimensions

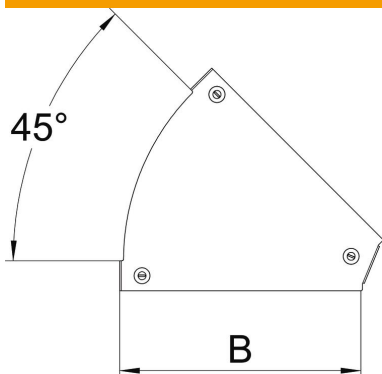

Width	600 mm
Width	24 in
Plate thickness	0.05 in
Plate thickness	1.25 mm
Dimension B	600 mm

### Technical data

Bend (angle)	45°
Fastening type	Sash lock
Maintain electrical functions	no
Suitable for mesh cable tray	no
Suitable for cable ladder	no
Suitable for cable tray	yes
Change of direction	Horizontal
Rustproof steel, pickled	no
Hinged	no