

# Technical data sheet

Edge protection ring KSR 20020, for LKM cable trunking type LKM 20020

Item number: 6249842



Edge protection ring for the open ends of LKM cable trunking.



**PVC** Polyvinylchloride

## Master data

|                     |                      |
|---------------------|----------------------|
| Item number         | 6249842              |
| Type                | KSR20020             |
| Description 1       | Edge protection ring |
| Description 2       | for LKM trunking     |
| Manufacturer        | OBO                  |
| Dimension           | 20x20mm              |
| Colour              | Grey                 |
| Material            | Polyvinylchloride    |
| Smallest sales unit | 5                    |
| Unit of quantity    | Piece                |
| Weight              | 0.9 kg               |
| Weight unit         | kg/100 pc.           |

# Technical data sheet

Edge protection ring KSR 20020, for LKM cable trunking type LKM 20020

Item number: 6249842



## Dimensions

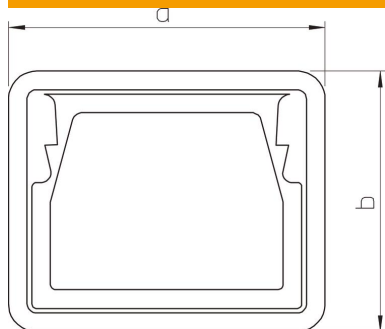

|             |       |
|-------------|-------|
| Length      | 23 mm |
| Width       | 24 mm |
| Height      | 28 mm |
| Dimension a | 24 mm |
| Dimension b | 28 mm |

## Technical data

|                                   |                        |
|-----------------------------------|------------------------|
| Type                              | Injection-moulded part |
| Suitable for                      | Cable routing duct     |
| Halogen-free                      | yes                    |
| Protection rating                 | IP30                   |
| Protection rating IK code         | IK10                   |
| Permitted temperature range, max. | 90 °C                  |
| Permitted temperature range, min. | -5 °C                  |