

Technical data sheet

Edge protection ring KSR60150, for LKM cable trunking type LKM 60150

Item number: 6249854



Edge protection ring for the open ends of LKM cable trunking.

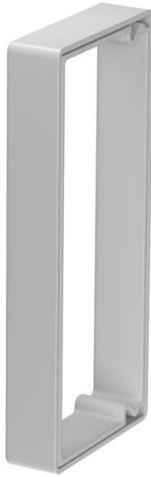

PVC Polyvinylchloride

Master data

Item number	6249854
Type	KSR60150
Description 1	Edge protection ring
Description 2	for LKM trunking
Manufacturer	OBO
Dimension	60x150mm
Colour	Grey
Material	Polyvinylchloride
Smallest sales unit	5
Unit of quantity	Piece
Weight	4.4 kg
Weight unit	kg/100 pc.

Technical data sheet

Edge protection ring KSR60150, for LKM cable trunking type LKM 60150

Item number: 6249854



Dimensions

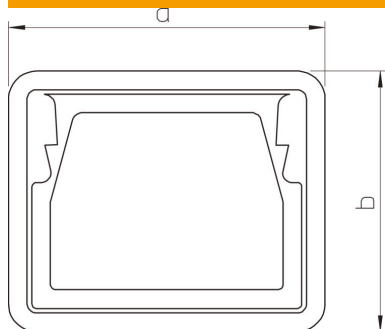

Length	21 mm
Width	154 mm
Height	68 mm
Dimension a	154 mm
Dimension b	68 mm

Technical data

Type	Injection-moulded part
Suitable for	Cable routing duct
Halogen-free	yes
Protection rating	IP30
Protection rating IK code	IK10
Permitted temperature range, max.	90 °C
Permitted temperature range, min.	-5 °C