

Technical data sheet

Hook-head screw ZL

Item number: 1148126



Hook-head screw for use with MS4022 profile rail



St Steel

ZL Zinc slat

Master data

Item number	1148126
Type	MS40HB M12x30 ZL
Description 1	Hook-head screw
Description 2	for profile rail MS4022
Manufacturer	OBO
Dimension	M12x30mm
Material	Steel
Surface	Zinc slat
Surface standard	
Smallest sales unit	50
Unit of quantity	Piece
Weight	7.55 kg
Weight unit	kg/100 pc.

Technical data sheet

Hook-head screw ZL

Item number: 1148126



Dimensions

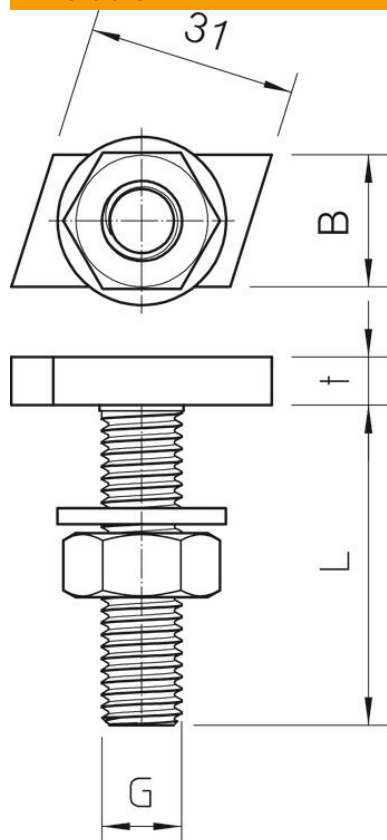

Length	35 mm
Width	14 mm
Height	7.5 mm

Technical data

Torque	27 Nm
Suitable for mounting rail	yes
Thread	M12x30mm
Thread metric	12