

Technical data sheet

90° bend 60 FS

Item number: 6043224

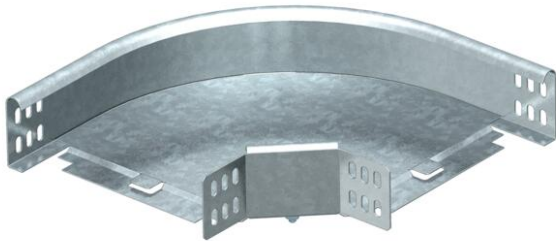

90° bend, horizontal, for all cable tray types of 60 mm side height.
The fitting is shipped in an unmounted state.
Including appropriate fastening material.



St Steel

FS Strip galvanized

Master data

Item number	6043224
Description 1	90° bend
Description 2	horizontal + angle connector
Manufacturer	OBO
Dimension	60x200
Material	Steel
Surface	Strip galvanized
Surface standard	DIN EN 10346
Smallest sales unit	1
Unit of quantity	Piece
Weight	110.3 kg
Weight unit	kg/100 pc.

Dimensions

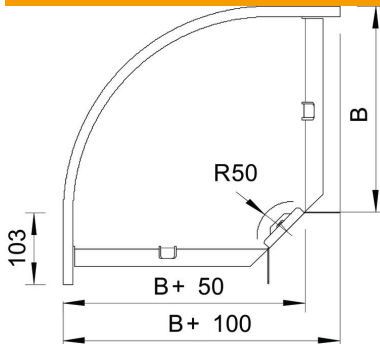

Width	200 mm
Width	8 in
Height	60 mm
Height	2 in
Dimension B	200 mm
Dimension R	50 mm

Technical data sheet

90° bend 60 FS

Item number: 6043224



Technical data

Bend (angle)	90°
Connector version	Supplied connectors
Maintain electrical functions	yes
Mounting perforation in base	no
NATO hole pattern	no
Change of direction	Horizontal
Rustproof steel, pickled	no
Side perforation	no
Wide-span version	no
Type of connector, cable support system	Screwed