

Technical data sheet

90° bend 85 FS

Item number: 7001762

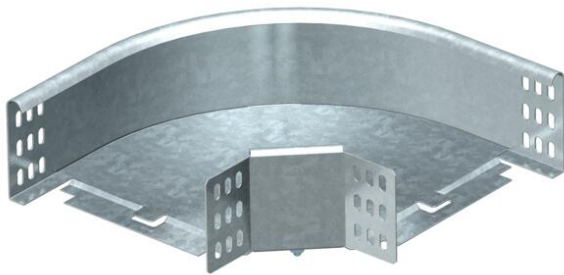

90° bend, horizontal, for all cable tray types of 85 mm side height.
The fitting is shipped in an unmounted state.
Including appropriate fastening material.



St Steel

FS Strip galvanized

Master data

Item number	7001762
Description 1	90° bend
Description 2	horizontal + angle connector
Manufacturer	OBO
Dimension	85x100
Material	Steel
Surface	Strip galvanized
Surface standard	DIN EN 10346
Smallest sales unit	1
Unit of quantity	Piece
Weight	65 kg
Weight unit	kg/100 pc.

Dimensions

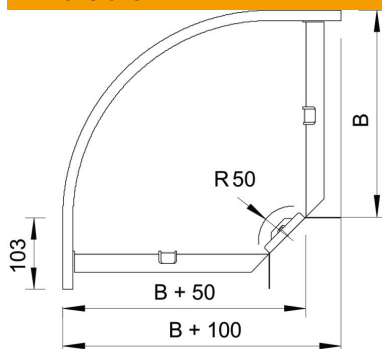

Width	100 mm
Width	4 in
Height	85 mm
Height	3 in
Dimension B	100 mm
Dimension R	50 mm

Technical data sheet

90° bend 85 FS

Item number: 7001762



Technical data

Bend (angle)	90°
Connector version	Supplied connectors
Maintain electrical functions	no
Mounting perforation in base	no
NATO hole pattern	no
Change of direction	Horizontal
Rustproof steel, pickled	no
Side perforation	no
Wide-span version	no
Type of connector, cable support system	Screwed