

# Technical data sheet

## Height-adjustable cassette for tube body, RKFNUZD3, stainless steel

Item number: 7409378

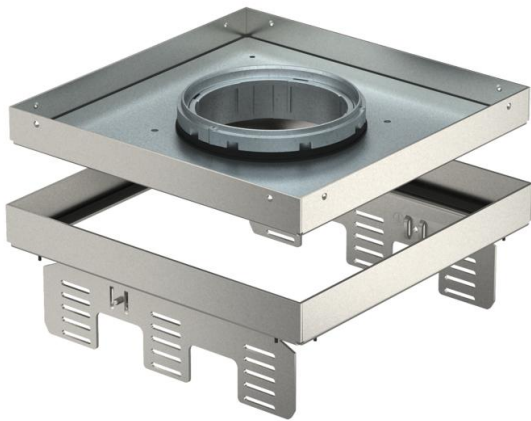

Height-adjustable cassette, decoupled from the floor, of nominal size 9, for tube bodies, for the installation of accessories in dry or wet-cleaned floors for indoor use, for mounting in underfloor boxes UZD250-3 or UZD350-3, either in conjunction with a mounting lid DUG../9 or in UGD250-3/9 or UGD350-3/9. Mounting takes place using height adjustment brackets (order separately) in the aluminium frame profile of the underfloor boxes.

Height-adjustable cassette for tube body, 3-compartment. 3 APMT5 cover plates can be installed. For the installation of 3 UT4 universal supports for 9 individual installation devices with support ring/support clamp or 12 Modul 45 devices.



A2 Stainless steel

### Master data

Item number	7409378
Type	RKFNUZD3 9VS20
Description 1	Square cassette
Description 2	for tube
Manufacturer	OBO
Dimension	243x243mm
Material	Stainless steel
Smallest sales unit	1
Unit of quantity	Piece
Weight	346 kg
Weight unit	kg/100 pc.

# Technical data sheet

Height-adjustable cassette for tube body, RKFNUZD3,  
stainless steel

Item number: 7409378



## Dimensions

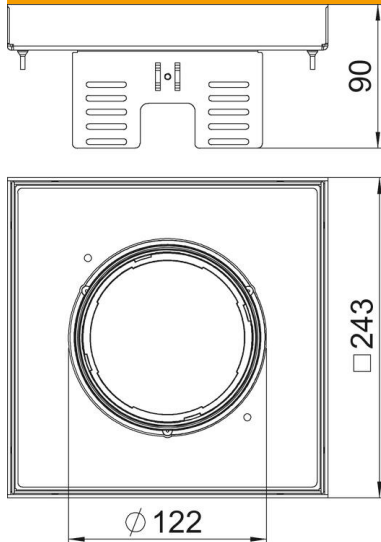

Length	243 mm
Width	243 mm
Height	90 mm
Dimension h	90 mm

## Technical data

Number of installable devices	12
Number of cable outlets	1
Version for	Square
Cable outlet version	Lowerable tube body
Floor care	Wet
Decouplable	yes
Floor height, min.	90 mm
Suitable for raised floor installation	yes
Suitable for cavity floor installation	yes
Suitable for underfloor box	250/350
Device support to accept mounting boxes	no
Length of installation dimensions	244 mm
Nominal size for device installation units	9
Protection rating (IP) when used	IP20
Protection rating (IP) when unused	IP40
Protection rating IK code	IK10
Heavy-duty version	no
Installation system type	UT4
Vertical load, large area	to 5,000 N
Approvals	VDE
Floor covering thickness	20 mm