

Technical data sheet

Support clamp, with pipe seat at bottom

Item number: 1488633



Support clamp for mounting pipes. Closed pipe seat at bottom. Fastening through knocking onto steel girders.

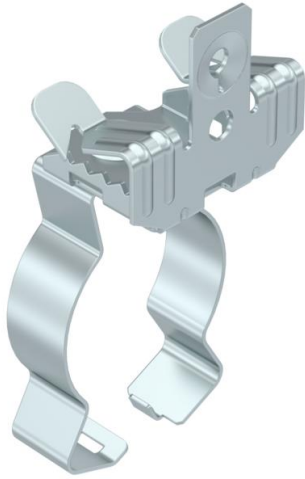

CE

- St Steel
- ZL Zinc slat

Master data

Item number	1488633
Type	SCVPC 7-13 D40
Description 1	Beam clamp
Description 2	with bottom pipe clamp 36-40mm
Manufacturer	OBO
Dimension	7-13mm
Material	Steel
Surface	Zinc slat
Surface standard	
Smallest sales unit	50
Unit of quantity	Piece
Weight	5.8 kg
Weight unit	kg/100 pc.

Technical data sheet

Support clamp, with pipe seat at bottom

Item number: 1488633



Dimensions

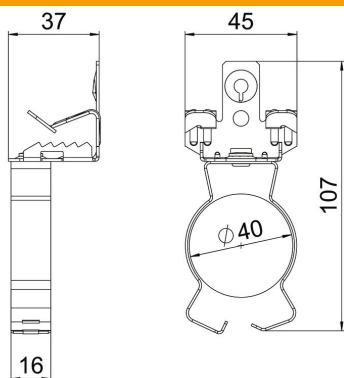

Length	110 mm
Width	45 mm
Height	37 mm
Dimension L	107 mm

Technical data

Connection type/component	Pipe/cable
Fastening type	Clamp
Flange thickness F max.	13 mm
Flange thickness F min.	7 mm
Pipe/cable diameter, max.	40 mm
Pipe/cable diameter, min.	36 mm
Hinge, adjustable	no
Hinged	no