

Technical data sheet

Medium-duty vertical cable ladder SLG 60, 6 m NS

Item number: 6207991

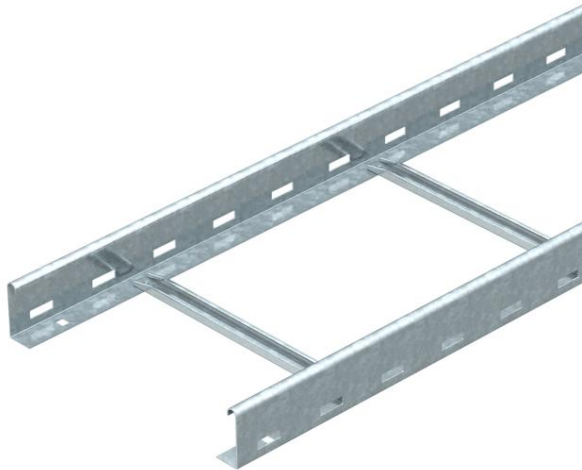

Cable ladder with 60 mm side height with riveted C profile rungs which are open in an upwards direction. Rolled side rail for reinforcement and as edge protection. Fastening to the bracket takes place using clamp, type LKS 40. The slot dimension of the frame is 11 mm and the appropriate U clamp is type 2056/N. Magnetic shield insulation without cover 10 dB, with cover 15 dB.



St Steel

FT Hot-dip galvanised

Master data

Item number	6207991
Description 1	Cable ladder
Description 2	heavy, perforated, NS rung
Manufacturer	OBO
Dimension	60x200x6000
Material	Steel
Surface	Hot-dip galvanised
Surface standard	DIN EN ISO 1461
Smallest sales unit	6
Unit of quantity	Metre
Weight	335.8 kg
Weight unit	kg/100 m

Technical data sheet

Medium-duty vertical cable ladder SLG 60, 6 m NS



Item number: 6207991

Dimensions

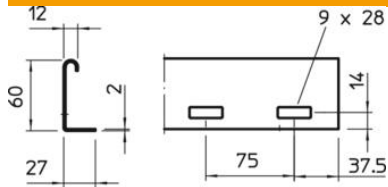

Dimension	60x200x6000
Length	6,000 mm
Length	6,000 ft
Width	200 mm
Height	60 mm

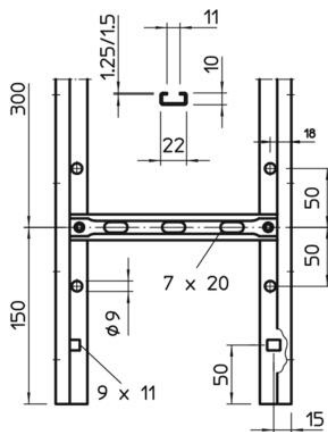

Technical data

Version of the rungs	Profile perforated
Side rail version	Flat profile
Fastening of rung	Blind riveted
Maintain electrical functions	no
Usable cross-section	98 cm ²
Usable cross-section	9800 mm ²
Rustproof steel, pickled	no
Side perforation	yes
Rung distance	300 mm
Wide-span version	no
Rail thickness	2 mm

Technical data sheet

Medium-duty vertical cable ladder SLG 60, 6 m NS

Item number: 6207991



Loads

Insertable support spacings, min.	1.5 m
Insertable support spacings, max.	4 m
Support spacing 1.5 m	3.1 kN/m
Support spacing 2.0 m	2 kN/m
Support spacing 2.5 m	1.5 kN/m
Support spacing 3.0 m	1.1 kN/m
Support spacing 3.5 m	0.6 kN/m
Support spacing 4.0 m	0.45 kN/m

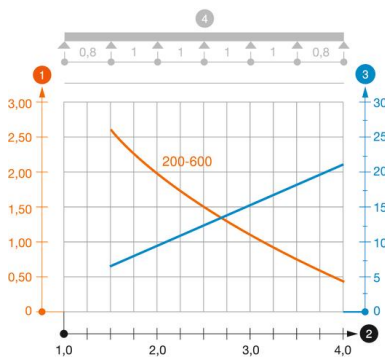

Load diagram, cable ladder, type SLG 60 NS

- 1 Permitted cable tray/ladder load in kN/m without man load
- 2 Support width in m
- 3 Rail bend in mm at permitted kN/m
- 4 Load scheme during testing
- Load curve with cable tray/ladder width in mm
- Strut bend curve according to support width