

Technical data sheet

Grounding clamp FS

Item number: 6016696



The connection and earthing terminal is used to reduce electrical resistance and therefore improves the electric conductivity in GRM mesh cable systems in the area of the joint. This allows fulfilment of the high demands in terms of the transition resistance according to, for example, NEMA and CSA. Furthermore, the connection and earthing terminal is compulsory when used as a protective conductor in a mesh cable tray system (national regulations have to be followed when creating such a system).



St Steel

FS Strip galvanized

Master data

Item number	6016696
Description 1	Connection and earthing clamp
Description 2	for GR-Magic
Manufacturer	OBO
Dimension	42x19x11
Material	Steel
Surface	Strip galvanized
Surface standard	DIN EN 10346
Smallest sales unit	25
Unit of quantity	Piece
Weight	3.8 kg
Weight unit	kg/100 pc.

Technical data sheet

Grounding clamp FS

Item number: 6016696



Dimensions

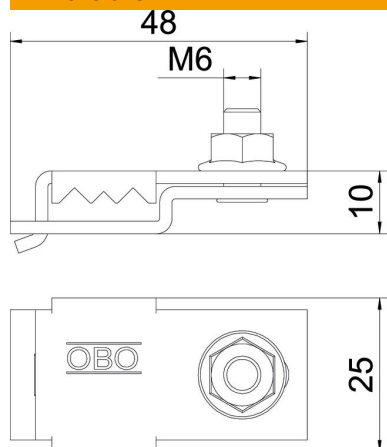

Height	11 mm
--------	-------

Technical data

Suitable for cable tray system height	11 mm
Suitable for mesh cable tray wire, max.	4.8 mm
Suitable for mesh cable tray wire, min.	4.8 mm