

# Technical data sheet

## 90° bend 160 FS

Item number: 6098703



90° bend, horizontal, for all wide span cable trays of 160 mm side height.  
For further stabilisation, additional supports should be planned for the area of the fittings.



- St** Steel
- FS** Strip galvanized

### Master data

Item number	6098703
Description 1	90° bend
Description 2	for wide span cable tray 160
Manufacturer	OBO
Dimension	160x200
Material	Steel
Surface	Strip galvanized
Surface standard	DIN EN 10346
Smallest sales unit	1
Unit of quantity	Piece
Weight	1390 kg
Weight unit	kg/100 pc.

### Dimensions

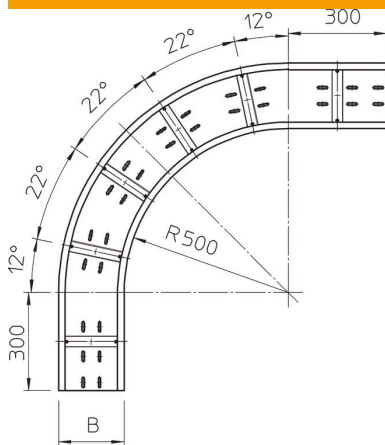

Width	200 mm
Height	160 mm
Plate thickness	2 mm
Dimension B	200 mm

# Technical data sheet

90° bend 160 FS

Item number: 6098703



## Technical data

Bend (angle)	90°
Connector version	Without connectors
Mounting perforation in base	yes
Change of direction	Horizontal
Rustproof steel, pickled	no
Side perforation	no
Wide-span version	yes
Type of connector, cable support system	Screwed